

LA-5748-MS  
Informal Report

C.3

UC-20  
Reporting Date: September 1974  
Issued: October 1974

CIC-14 REPORT COLLECTION  
**REPRODUCTION  
COPY**

Magnetic Energy Transfer and Storage  
(METS) Program Schedules for a  
Fusion Test Reactor (FTR)

by

J. D. Rogers  
C. E. Swannack  
K. I. Thomassen  
D. M. Weldon



**los alamos**  
**scientific laboratory**  
of the University of California  
LOS ALAMOS, NEW MEXICO 87544

UNITED STATES  
ATOMIC ENERGY COMMISSION  
CONTRACT W-7405-ENG. 36



In the interest of prompt distribution, this LAMS report was not edited by the Technical Information staff.

Printed in the United States of America. Available from  
National Technical Information Service  
U.S. Department of Commerce  
5285 Port Royal Road  
Springfield, Virginia 22151  
Price: Printed Copy \$4.00 Microfiche \$1.45

This report was prepared as an account of work sponsored by the United States Government. Neither the United States nor the United States Atomic Energy Commission, nor any of their employees, nor any of their contractors, subcontractors, or their employees, makes any warranty, express or implied, or assumes any legal liability or responsibility for the accuracy, completeness or usefulness of any information, apparatus, product or process disclosed, or represents that its use would not infringe privately owned rights.

MAGNETIC ENERGY TRANSFER AND STORAGE (METS) PROGRAM

SCHEDULES FOR A FUSION TEST REACTOR (FTR)

by

J. D. Rogers, C. E. Swannack, K. I. Thomassen and D. M. Weldon

ABSTRACT

A plan with schedules for the magnetic energy transfer and storage (METS) program for a fusion test reactor (FTR) is presented for component and materials development. The plan extends into FY's 78 and 79 and leads to the design, fabrication and operation of an applied helical-field half wavelength section of a coupled superconducting prototype system to demonstrate engineering feasibility. Facilities, components, materials, costs, and manpower are discussed in relation to the program plan and schedules.



INTRODUCTION

As early as 1968 small scale experiments were conducted at the Los Alamos Scientific Laboratory to explore the possibilities of storing energy in superconducting inductive coils and to devise means of transferring the stored energy in short times. The transferring mechanism was approached by developing superconducting elements to perform as fast acting switches. This very early work was the genesis of a program to create an inductive energy storage system for fusion experiments and for fusion reactors. The immediate program is directed toward the establishment of a sound engineering basis or feasibility demonstration of a  $\Theta$ -pinch fusion test reactor (FTR) as the next large scale experiment to be conducted as a successor to Scyllac.

The program, however, has broader implications since the development of pulsed, reversible, magnetic energy supplies is necessary for other fusion devices as well. A very important application is for the ohmic heating, vertical field, and magnetic limiter supplies in Tokamaks. All these are pulsed, have rapid initial rise times (even in reactors) and involve large quantities of energy which must

be conserved. In TCT, for example, there are 115 MJ and 25 MJ respectively in the ohmic heating and vertical field supplies. Yet, the energy output for this "breakeven" device is only 3 MJ, coming from the  $10^{18}$  neutrons in a pulse (at 20 MeV/neutron). This output represents approximately 0.1% burnup in one energy containment time, while reactors will operate at several percent burnup and may burn for ten containment times. Nevertheless, it is unlikely that the energy from the ohmic heating supply can be wasted even in a reactor. In the UWMak design that energy is 50 GJ.

While present and next generation Tokamak experiments use conventional power delivery equipment, the power levels are sufficiently high that devices beyond TCT will likely require fast inductive energy storage systems, and the development in the METS program will be directly applicable.

The early small scale experiments with superconducting energy storage coils and superconducting switches demonstrated the soundness of the underlying physics principles of storing energy in magnetic fields and of transferring out that energy in

millisecond times. The switching to initiate the transfer was accomplished by pulsing or driving a superconducting switch into the normal conducting state in microseconds with energy from a capacitor bank. The energy transfer time from the storage coil is then characterized by the circuit parameters of the system.

Broad based engineering studies of a METS superconducting storage and transfer system with superconducting switches indicated that costs related to the switches would be high and these were mostly reflected in liquid helium refrigeration capacity. An alternative circuit breaker switching system is consequently under development.

This document deals in detail with program planning, schedules, costs, and manpower for parts of the program for the next several years as related to creating an FTR. The information is generally displayed in bar graph form with projected accomplishment expectations to satisfy the Management By Objective (MBO) criterion.

#### METS-FTR SYSTEM

The FTR, as presently conceived, is a toroidal system with the major plasma radius to be 35 m to 55 m, to be shock heated in microseconds with a maximum magnetic field close to 1-2T. This heating is to be followed in time with the main compression field of 6 T imposed on the plasma with a 1 ms half-cycle approximately sinusoidal rise time. The energy for the compression coil is transferred from the superconducting inductive energy storage system and is trapped in the compression coils by shorting switches or crowbars across them. The hardware which stores and transfers the energy for the compression field is the METS system.

Figure 1 is a circuit diagram for a METS-FTR system. For a 35 m radius FTR, the toroidal plasma circumference is 220 m. Practical considerations restrict currents in the concentric superconducting inductive storage ring to 20 kA and a magnetic field of 3 T with a 60 kV transfer voltage for a 1 ms transfer time. This corresponds to a storage coil or module length along the plasma of one-eighth of the applied helical-field wave length. This module length is readily adapted to power the sections of the compression coil which must generate this contoured field to compensate for plasma drifts and

instability. This  $\lambda/8$  length is the repetitive module on which the circuit is based. For a 220 m circumferential toroid there would be 800 such modules.

Table I lists the METS-FTR circuit components and describes their functions. The notation of Fig. 1 locates these elements in the circuit. A brief discussion of the operational sequence of the system follows to make clear how the energy storage and transfer process occurs.

In the initial state the submerged contactors,  $B_1$ , are closed and the vacuum interrupters,  $B_2$ , and isolating switches,  $B_3$ , are open. The storage inductors are charged in series by ramping the current from the main energy supply to 20 kA in 300 s. At the same time the counterpulse energy is supplied to the transfer capacitor bank,  $C_1$ . This raises the entire system above ground by several kV. The high-voltage vacuum interrupters are closed and the submerged contactors are then opened. This transfers the 20 kA to the breaker circuit external to the liquid helium inductive storage coil dewar. The vacuum interrupters are then opened and they draw a low voltage arc for several milliseconds until the gap spacing is sufficient to hold the high voltage which develops during the transfer cycle. At this time the counterpulse is triggered from the  $C_1$  capacitor bank. The 20 kA current in the interrupter is commuted through zero at the proper rate as determined by  $L_3$  and  $C_2$  to allow for de-ionization and complete arc interruption. The current then transfers resonantly with some small cable or transmission line losses from the storage coil module through the transfer capacitor into the compression coil. At the end of the 1 ms transfer period the crowbar,  $B_4$ , is closed, trapping the current and energy in the compression coil. Shortly thereafter the in-line contactors,  $B_5$ , close, relieving the  $B_4$  crowbar and assuring equal dB/dt in the full torus.

#### PROGRAM AND ASSUMPTIONS

To demonstrate the feasibility of the engineering practicality of the METS-FTR system, a  $\lambda/2$  Coupled Superconducting Prototype System is to be designed and operated. This system, composed of four modules of the type to be used in a complete METS-FTR system, will incorporate almost all the components of the large system. The program dis-

cussed herein treats in turn the various items of hardware to be developed, the separate schedules for their development with specific intervals for their stepwise accomplishment, and the costs related to the program. The planning is tied closely to certain long lead items -- namely the 375 kJ,  $\lambda/8$  Prototype Energy Storage Coils and the 700 W, 4.5 K Pulsed Load Refrigerator. The overall schedule is intended to meet FY-78 - FY-79 operating dates for the  $\lambda/2$  prototype system. The system components requiring development are readily identified from Fig. 1. Other items which are ancillary to the  $\lambda/2$  prototype system but are needed to support the development are explained in the narrative which follows.

Certain premises are inherent in the program and schedule presentation. These are that the development proceeds in each activity in a successful manner, that no unusual delays are encountered, and that realistic and timely funding is provided. Further, in those activities for which costs have been estimated (there are many) the presumption is that they are close to what the real costs will be. No effort has been made to include an inflation factor. In some instances funds for development may be of limited value if they are allocated for specific items since the sequence of events will depend strongly upon prior funding and progress for other items. For example, such is the situation for development of superconductor and cable for the 375 kJ prototype coils. The superconductor development cannot be undertaken until such time as the design of the coils is well under way. Generally, funding levels are specific for a few years, necessarily become more indefinite for the protracted periods, and will be refined from time to time as information develops. Major procurement expenses funds (other than direct and indirect personnel, materials and services less than \$2000 per item, and capital equipment costs) and unusual capital costs are given specifically. Items covered from routine general operating expense (direct and indirect personnel costs and materials and services costs less than \$2000 per item) are so noted without any dollar amount specified.

#### SCHEDULES, COSTS, AND MANPOWER

Figure 2 gives bar graph schedules extending into FY-79 for the Los Alamos Scientific Laboratory Magnetic Energy Transfer and Storage Program. It is divided into seven major categories or sub programs. These are

- I. Energy Storage Coils
- II. Superconductor
- III. Cryogenics
- IV. HVDC Interrupter Facility
- V. 375 kJ Superconducting Energy Storage Facility
- VI.  $\lambda/2$  Coupled Superconducting Prototype System
- VII. Room Temperature METS-FTR  $\lambda/2$  Test Module

The solid triangles on the bars signify completed tasks and the inverted open triangles above the lines indicate projected completion dates for planned tasks.

I. Basic to the program is the storage coil. These coils are superconducting and perform for the FTR the function of the capacitor banks in Scyllac, being the primary energy store. They are superconducting since they constitute a technology necessary for reactor use, namely, the creation of a compact, low loss energy store. The coil development program involves the completion of small scale tests; fabrication and testing of low energy loss 300 kJ superconducting storage coils; and development, fabrication, and testing of 375 kJ superconducting FTR prototype energy storage coils. The 300 and 375 kJ coils are designed and fabricated by industry as an industrial qualification program. This work is intended to establish industrial sources which can supply the 800 coils for the FTR on a competitive bid basis.

I-1 shows the 30 kJ system being converted in early FY-75 to be able to run small scale capacitance transfer tests. The system will then be used to study the physics of resonant energy transfer from a superconducting storage coil. Of particular interest will be the measurement of the triggering energy required for a superconducting switch with resonant energy transfer in comparison to earlier measurements based upon an exponential transfer into a resistive load. This set of experiments

is a part of the program for FY-75 to carry superconducting switch development to the point where that technology can be considered as a backup for the evolving HVDC interrupter development. This work is funded for FY-75 from the general operating expense budget and will become a low level effort thereafter. The manpower expenditure is near two man months professional and three man months technician.

I-2 shows the 300 kJ coil development program. It includes the schedule for the highly successful LASL coil which will be used this FY as an energy store to test superconducting switches. Thereafter the coil will be available as a work-horse energy store for experimental work with HVDC interrupters and capacitance transfer systems. The coil was built out of FY-74 major procurement funds and its operation and use will be supported from the general expense operating budget. The manpower support for using the coil is assigned to the superconducting switch and interrupter facility program.

I-2 also includes the three, 300 kJ coils being designed and fabricated by Magnetic Corporation of America (MCA), Intermagnetics General Corporation (IGC), and Westinghouse as a part of the industrial qualification program. The coil fabrication, Phase II, should be complete by the end of FY-75 at a total cost of \$268,000. Delivery of the coils is paced by the production of the superconductor. See II-3. A part of these coils was funded from FY-74 major procurement and the balance -- \$108,000 -- is being funded from the FY-75 major procurement budget. The coils are to operate at 10 kA and withstand 40 kV during the energy transfer period of 2 ms with an energy loss of less than 0.3% of the stored energy. The specifications for these coils are found in Appendix A. Testing of the pulsed coils should be complete by mid FY-76. This is considered to be one of the major objective dates in establishment of METS-FTR engineering feasibility. Capacitance transfer testing with the coils will coincide with and follow the basic coil tests. The manpower level of effort associated with this testing is expected to average two or three professionals and a similar level of technician support from the time of receipt of the coils through the testing effort.

I-3 shows the 375 kJ,  $\lambda/8$  FTR prototype coil development program schedule. This work will be a continuation of the industrial qualification program and is the key to having the  $\lambda/2$  Coupled Superconducting Prototype System in operation in early FY-78. The intention is to have industry design in complete detail, prototype coils to operate at 20 kA to withstand 60 kV during the 1 ms transfer period with total energy losses to be less than 0.3% of the stored energy. The desire is to obtain machine shop working drawings, complete specifications and manuals to form the basis of a potential competitive bid for ordering a number of these coils. The prototype design is to encompass all considerations of an 800 module METS-FTR energy storage coil ring. The specifications for the coils for this design work are given in Appendix B. The design work is to be completed in FY-75, is to provide preliminary superconductor specifications to initiate that development program, is to provide final superconductor design specifications for early placement of superconductor orders, and is to be followed by the fabrication of four  $\lambda/8$  coils in FY's 76-77 with individual coil tests complete by early FY-78. The coils will then be installed in the  $\lambda/2$  prototype system for its operation in FY's 78 and 79. The cost of each design contract for the FY-75 work is estimated to be \$125,000.

Funds are not available in the FY-75 major procurement budget to enter into two such contracts. This limitation will eliminate at least one or two of the present industrial participants from the qualification program. To maintain three companies in the program, \$225,000 additional FY-75 funds are required. The cost of making each coil is estimated to be \$100,000 spread over FY's 76 and 77 for a total of \$400,000 for four coils. This amount is exclusive of the cost of the superconducting wire and its associated cable development. See II-4 for the conductor costs. The schedule for the 375 kJ coils is determined by the expected availability of superconductor. Experience has shown that the industrial capacity is very limited and most probably is related to the fact that there are no integrated superconductor suppliers. The job-shop methods presently in use to make conductor, the large cost of having materials inventories, and

the erratic nature of contracting work all function to the detriment of the supplier and his customer. The manpower for installing and testing the 375 kJ coils is comparable to that given above for the 300 kJ coils under II-2.

II. The fabrication of the energy storage coils depends entirely upon the successful development of superconductor which has low energy losses during the energy transfer operation. An energy loss, from all sources, criterion of less than 0.3% of the stored energy is used and has been selected as a step toward the development of a reactor (RTPR). Theory indicates that filaments of superconductor, Nb-Ti, which are electrically insulated from one another and which are transposed with respect to each other will have a minimum energy loss when the superconducting strand undergoes a rapid magnetic field change. A compromise from the ideal is devised in a practical conductor. Multi-filament strands of superconductor are twisted; and the matrix material, copper, immediately surrounding each filament in the strand serves as an electrical and thermal stabilizing material; and the Cu-Ni, 70-30 alloy sheath surrounding the copper - Nb-Ti acts as an imperfect insulator but does serve to reduce the eddy current losses. The individual strands vary in diameter from 0.010 inches to 0.030 inches in diameter in the designs and are used to form a cable to carry the currents needed for the energy storage coils. Thus strands of insulated superconductor are braided or twisted together, and these substrands are twisted together to form the final cable to carry from 10 to 20 kA.

Conductor used for superconducting switches requires similar precautions to minimize losses and instabilities in the superconductor and to minimize the amount of superconductor used in such switches; only CuNi is used in the matrix. The switches are constructed in a noninductive manner with very low magnetic fields. This feature also minimizes the amount of material required to carry a given current in a particular switch design.

Systems analyses based upon physics experiments and theory show that for an optimized FTR experiment that about 10% of the stored energy is lost in the superconducting switch when normal during the transfer period. An additional 10%

equivalent of stored energy is lost in the switch when it is driven normal from its triggering power supply. These two effects are large heat loads on the system and require expensive refrigerator systems with heavy power demands. A policy decision has been made to carry the superconducting switch development to an appropriate point of departure this fiscal year so that it can be used, if needed, as a backup for the vacuum interrupter program. Superconducting switch wire development parallels this policy.

II-1 shows the superconducting switch wire development program which will be complete this FY and is fully funded. The superconductor is 0.0082-inches diameter; 1.3 Cu-30Ni matrix to 1.0 superconductor ratio; and 320 Nb-Ti filaments; strand twist of 10 per inch with short sample characteristics of at least 16 A at 50 kG, 38 A at 20 kG, 50 A at 10 kG, and 98 A at 5 kG. Most of the conductor is on hand and what is not received needs only to be insulated before delivery. The conductor use on switches is discussed under III-8 below. The tests on the conductor strands show good performance. Final evaluation will result from the actual switch tests.

II-2 is a complex matrix conductor development program using Cu-30Ni, Cu matrix with Nb-Ti filaments. The program was established to learn how to make superconductor suitable for the IGC and Westinghouse 300 kJ energy storage coils. Sample material has been received and is undergoing short sample critical current and hysteresis and eddy current loss measurements. More pilot run samples are due soon for measurements. Measurements on this material will determine the final parameters on the material of item II-3. A good portion of the conductor from the pilot runs is being used by IGC and Westinghouse to develop methods for making cable. The material requires \$12,785 FY-75 funding presently allocated in our major procurement budget. Manpower required to complete the pilot wire evaluation is about one professional man month and one to two technician man months. The 300 kJ coil design of MCA uses conventional monofilament Nb-Ti in a copper sheath and requires no development work.

II-3 is the superconductor to be used in fabricating cable for the IGC and Westinghouse 300 kJ energy storage coils. The delivery time for these materials is determining the fabrication schedule for the 300 kJ coils. See I-2 above. Results from measurements on pilot run (II-2) will be used to fix the strand diameter, heat treatment, and twist rate for the wire produced for the 300 kJ coils. Wire delivery is scheduled into Nov. 1974 with the late delivery material being excess in case some of the early fabricated conductor is faulty. The conductor being made is nearly identical in design to that described under II-2. The IGC order requires 260 lb of conductor and the Westinghouse order 250 lb. To complete the work on the wire for 300 kJ coil fabrication will require funds in the following amounts: - IGC \$29,989; MCA \$23,096; and Westinghouse \$41,212 - for a total of \$94,297 which is allocated from our current FY-75 major procurement budget. The remaining manpower requirement effort for LASL for evaluation of the individual conductor strand material is like two professional man months and two to three technician man months.

II-4 enters into a new superconductor development program for the 375 kJ-FTR prototype coils which is divided into three activities, namely, the conductor development on a preliminary basis from two to three suppliers, conductor fabrication for four  $\lambda/8$ , 375 kJ-FTR prototype coils from several sources, and the development and assessment of mass production capabilities to make superconductor for the entire 800 module toroidal energy storage ring. The superconducting wire strands are expected to be very similar to those designed for the 300 kJ coils; however, the current capacity is doubled to 20 kA and the voltage across the coils is to be 60 kV, not 40 kV. In addition the energy loss criterion of less than 0.3% has been retained while the transfer time is reduced from 2 ms to 1 ms. This creates new demands upon the conductor and early development work is required to maintain the schedules proposed. An important interlocking schedule is involved between the design of the 375 kJ-FTR coils (I-3) and the preliminary and final superconductors (III-4). The specification for the wire and built-up cable must come from the

375 kJ-FTR coil design work to be performed by industry. Thus independent funding of the superconductor program without timely performance on the 375 kJ-FTR coil design is of little assistance. None of the work set out in II-4 is funded in FY-75 and the proposed program including the 375 kJ-FTR prototype coil fabrication cannot proceed on the projected schedule (See I-3) without the superconductor development discussed here. The preliminary development work is expected to cost about \$200,000 over FY's 75 and 76, most of which would go to industry. The costs would be spread nearly equally over the two years. About \$30,000 of the cost would be part of the LASL normal operating expense, whereas the remainder, \$170,000, is newly needed major procurement money to maintain the proposed schedule. The manpower effort for this work is estimated to be near 50 man months. The new funding required for the conductor under II-4 for the 375 kJ-FTR coils is expected to be \$412,000. Of this amount about \$375,000 would go to industry and would be mostly a FY-76 major procurement expense item. The balance of about \$37,000 would be part of the LASL normal operating expense budget. It must be remembered that the costs are for conductor for four  $\lambda/8$  coils. The manpower effort is estimated to be near 130 man months.

The program plan for developing the superconductor for the 375 kJ-FTR prototype coils is to have the industrial organizations which are involved in the coil qualification program to assume the responsibility for the conductor development consistent with their designs. Our earlier and present experience with the 300 kJ coil development program has clearly defined the problem areas related to conductor fabrication. As the qualification program proceeds, industry must understand and cope with these areas and be able to develop reliable schedules with an appropriate quality assurance program related to coil production. LASL will maintain a very definitive control over the superconductor development and production even with the basic procurement responsibility placed with the coil manufacturers. Our projected contractual relationship is intended to assure the strong LASL participation.



The third component of the 375 kJ coil superconductor development program is to examine the problem of mass production quantities of superconductor. This program will utilize results from the interlab effort (ORNL, LASL, NAL, and LBL) presently underway to make improved Nb-Ti superconductor. Its goal will be to find ways and means to make large quantities of superconducting wire and cable at a low cost. Larger size extrusion billets and hydrostatic extrusion will be considered. This work should be done with one conductor supplier who has good facilities with considerable flexibility of processing, since the effort will require a high level of interaction with LASL on an experimental basis. The cost of the work spread over FY's 75, 76, and 77 will be \$200,000 most of which will be spent in FY-76 and will go to industry. Of the \$200,000, about \$50,000 will come from the regular LASL operating expense budget and the balance from major procurement. Manpower effort for the work is estimated to be 53 man months.

II-5 is a program to evaluate all the information available from the ORNL-LASL Nb-Ti development work and to make the then best available complex matrix copper, Cu-Ni, Nb-Ti superconductor. This should be done on small extrusion billets by several suppliers under direct contract with LASL to determine which companies are best qualified to bid on the wire to be supplied for the 800 module energy storage ring. This would be the most advanced conductor available within the mainstream of the present program. The cost of the program to be spread over FY's 76 and 77 is estimated to be \$82,000. About \$55,000 of the cost would go to industry and the balance would be normal LASL operating expense money. Estimated man months for the work are 24.

II-6 provides a schedule for developing some new conductor concepts with possible very low energy loss characteristics under transient operations. Such conductor would be useful both to FTR coil design and ultimately to reactor (RTPR) use. The concept is to develop a complex matrix superconductor in which the Cu-30Ni alloy separating the multifilaments is replaced by Cu-55Ni, monel, or some other high resistance material.

This work, if funds become available, could be initiated as a Phase I pilot run by mid FY-75 going into FY-76. It should be done with only one supplier on a purely experimental basis for evaluation. The new major procurement funds needed would be about \$55,000 which would be spent with industry. The total program cost would be \$85,000; and about \$30,000 of that would be normal LASL operating expense budget funds, all of which would be spent mostly in FY-76. About 24 man months would be used on the work.

Phase II of II-6 would go into practical conductor production of the best conductor resulting from the pilot run and would be pursued with several suppliers to established industrial qualification. The program will run over FY's 77 and 78 in the main. The Phase II of II-6 cost is estimated to be \$259,000. Of this amount about \$225,000 would be money spent with industry requiring major procurement funding. The balance would be mostly LASL normal operating expense. Man months estimated for the work are about 93 spread over FY's 76, 77, and 78.

The third component of II-6 is to develop mass production capability of the high resistivity matrix superconductor in a manner and for the reasons given for the Cu-Ni, Cu matrix conductor under II-4. This work is to be done in FY's 77 and 78 and is estimated to cost \$180,000. Of that amount about \$150,000 is to be spent with industry from major procurement funds. The balance is to come from LASL normal operating expense funds. Man months required are estimated at 50.

II-7 outlines a schedule for upgrading the experimental facility for measuring the physics characteristics of the superconducting wires for switches and coils. The low current short sample critical current apparatus is complete, and the high current short sample critical current apparatus to operate on 10 kA conductors with a flux pump capable of delivering 25 kA is complete. A new flux pump which will provide up to 60 kA current is to be added in early FY-75. The loss measurement apparatus to determine hysteresis and eddy current losses is nearly complete and operational. The present high current short sample critical current apparatus is to be modified, if

possible, to use for measurements on 20 kA conductor. This may demand enlarging the bore through the dipole magnet which supplies the field. This will be done this fiscal year; and if not possible, a new dipole and dewar system will be constructed as represented by the last entry under II-7. The II-7 program is entirely funded out of FY-75 monies except for the development of the new dipole system. The likelihood of modifying the existing dipole is small and plans for the new one should be made now. The total new funds for this is estimated to be \$120,000. Of this amount \$30,000 would be for capital equipment, \$50,000 would be new major procurement money, and the balance of \$40,000 would be salary and miscellaneous out of the normal laboratory operating budget. The new capital equipment funds would be used in FY-75 if they became available immediately and the major procurement expense money would be costed about equally in FY's 75 and 76.

Category III deals with the major cryogenic component development and has eight sub-programs. These range from conceptual studies of the cryogenic system for the FTR on a contracted consulting basis to development of electrical leads, etc. These will be discussed in turn.

III-1 is a conceptual study of the cryogenic system for an FTR and has been done in two phases. The study has been contracted as consulting services supplied by Cryogenic Consultants, Inc. The first phase is complete and is a study, including costs analyses, of the entire FTR cryogenic system with superconducting switches. The second phase is a similar study without superconducting switches and is essentially finished. This latter study assumes that switching will be by use of HVDC vacuum interrupters. The studies are completely funded. The FY-75 funds allocated from major procurement expense for this purpose are \$9,200. The information generated from these studies is to be used as supporting inputs to the advanced design work now under way for the conceptual FTR proposal to the AEC.

III-2 is the schedule for a 700 W, 4.5 K pulsed load refrigerator. This is a long lead item and is to be used on the  $\lambda/2$  Coupled Superconducting Prototype System. See VI. The machine

can also supply the liquid helium needs for other METS experiments. All major components of the unit for a total of \$563,000, already funded from FY's 74 and 75 funds, are now on order except for the transfer lines. These are to be ordered in late FY-75 and to be paid for from FY-76 major procurement funds. Refrigerator equipment drawings will be required almost immediately as will the FTR prototype dewar drawings so the cryogenic system layout can be established. Only then can the transfer lines be defined and ordered. The transfer lines are estimated to cost \$100,000 and will be expense items for which FY-76 major procurement funds must be allocated. The 700 W refrigerator together with the 375 kJ-FTR prototype coil and the FTR prototype dewar will undoubtedly pace the planned assembly and operation of the  $\lambda/2$  system. Since the refrigerator is a new capital equipment item, its installation will require additional capital funds estimated to be \$140,000 for FY-76. Installation should be complete by mid FY-77 and the system tested and in operation by late FY-77.

III-3 gives the schedule for the FTR prototype dewar. This is to be a segment of the toroidal dewar which is to contain the 300 MJ-800 module superconducting energy storage coil. It is presently conceived to be a development of the conceptual study of III-1. The dewar will test a number of the structural concepts developed in that study and perfect a workable dewar. This dewar will be used in the  $\lambda/2$  coupled prototype system with four 375 kJ-FTR prototype coils. The dewar is first to be designed on a contract basis for \$18,000 out of FY-75 major procurement funds and to be ordered at the first of FY-76 from major procurement funds for that year. Its estimated cost, to be better fixed by the design work, is probably \$125,000. The schedule assumes a one year fabrication time which may be somewhat optimistic, in which case the cost will be spread into FY-77. This situation characterizes one of the major difficulties related to fiscal year end purchases of large items when funds cannot be carried over from one fiscal year to another whereas production schedules often slip and are unpredictable. No manpower estimate for making the

installation has been developed as this will be included in the  $\lambda/2$  coupled prototype system. See VI.

III-4 schedules a plastic dewar to be used for testing the 375 kJ-FTR prototype coils on an individual basis. The dewar will be installed into the 300 kJ test facility and the entire facility is to be upgraded to the 375 kJ level. See V-5. The dewar is to be fabricated from plastic-laminated fiberglass shells with a plastic-laminated lid. A liquid nitrogen radiation shield will be used in the vacuum space. The shield will be split vertically in a number of places over its length to prevent field coupling and eddy current losses during the pulsed coil tests. Cost of the dewar should be \$35,000 from FY-75 major procurement funds and delivery is expected to be at the end of the fiscal year. A late delivery due to schedule delays presents a funding problem similar to that discussed above for the FTR prototype dewar. See III-3. Installation and testing should be complete by the end of FY-76. The delay in installation is intentional to enable testing of the 300 kJ coils to be completed. See I-1. The LASL manpower effort for the dewar design, installation, and testing is about one professional man month each on design and installation and five technician man months on installation and testing, all to be funded from the normal operating expense budget.

III-5 represents a schedule of several important input-output objectives to have the  $\lambda/2$  FTR prototype system developed on schedule and is listed under category III because of their basic cryogenic nature. Refrigerator drawings are needed to make the system layout drawings, dimensioned transfer lines should result from the layout, and final engineering installation drawings need to be on hand by the first of FY-76 to meet the schedules.

III-6 is a series of schedules for electrical leads. Figure 1 indicates that steady state charging leads are required to carry currents up to 20 kA at the end of a 300 second charge period. For a modest design factor, the leads will be made to carry 25 kA. On a large 800 module system or a four module,  $\lambda/2$  prototype these can be located at a low voltage point in the system and need only to be insulated for 5 kV. This is the bias voltage

applied to the transfer capacitor bank for counter-pulsing the HVDC vacuum interrupters. To test individual 375 kJ-FTR prototype coils at 60 kV, a different continuous electrical lead will be needed since one side of the coil will reach the high voltage during the pulsed transient. \$25,000 FY-75 major procurement funds are allocated for this work; however, this may be insufficient. The more likely need will be for two to three times this amount for two commercially designed and fabricated continuous duty electrodes most of which will be FY-76 costs of an additional \$50,000. Manpower for installing and testing these electrodes is included in the installation and testing of the plastic dewar, III-4, and in the upgrading of the 300 kJ test facility to 375 kJ, V-5.

The pulsed leads for operation with the vacuum interrupters and which must also be operated at voltage up to 60 kV will be designed and fabricated at LASL with funds from the normal operating expense budget. Their installation and testing coincide with that of the plastic dewar for testing the 375 kJ coils individually. These pulsed leads, Fig. 1, are for direct coupling of the energy from the storage coils to the compression coils.

III-7 deals with a component which is critical to the entire concept of using vacuum interrupters for switching METS. During the charging period for the energy storage coils the current which builds up to 20 kA cannot be shunted in and out of the storage coil dewar to the vacuum interrupters at each of the 800 modules. The heat load to the 4.5 K level through 800 pairs of continuously operating electrical leads is so high that operation in that mode is prohibitive. This requires the invention and development of a submerged contactor between each of the superconducting coils. The contactor will carry the 20 kA while the coils are being charged and will only be opened just prior to switching with the vacuum interrupters. At that time the contactors must stand off 60 kV. For the  $I^2R$  losses to be very low each of these submerged contactors must have a resistance in the nano-ohm region. The initial plans are to do the first design and development in the laboratory within the scope of our normal operating budget. The schedule shows completion at a time to have

the switch tested and operational to correspond with the early use of the 375 kJ coil plastic test dewar. However, the contactor might well be tested in the existing 300 kJ test facility. The extent of manpower to be devoted to this item is under study and is not known at the present time. We consider this an involved, high priority engineering development and are presently investigating its complexity and consequently the effort to expend on it.

III-8 schedules the superconducting switch work discussed above in several places and is to be completed this fiscal year. Major procurement costs this year are only \$4,000. Manpower for this work is estimated to be about four to six professional man months and a nearly equal amount of technician time. The switches being pursued use the superconductor discussed under II-1. The switches themselves are of two very low inductance configurations, namely, a collection of series and parallel connected subcomponents made by braiding sleeves of superconductor over plastic forms and for the second type a collection of series and parallel connected subcomponents made by folding a braided superconductor back and forth on itself in a compact hairpin-accordion planar array. Both types of switches are stabilized with epoxy potting. The switch components can be built up to give almost any current-voltage or resistance combination. Tests already made on individual components and on a few components in parallel look promising. These kinds of switches require very low resistance contacts in the series-parallel connections.

IV. Category IV covers some of the most important work for the next two fiscal years. A policy decision has been made to abandon the use of superconducting switches in the METS system because of the high capital costs and large amount of 4.5 K refrigeration required for an FTR. The alternative to be explored at length is to develop either a HVDC vacuum interrupter switch based upon commercially available vacuum breakers or to develop a switch based upon the evolving plasma valve of Hughes Research Laboratories. The latter offers certain apparent advantages in that there are no moving parts; however, the valve is not a proven production item. A facility for testing the interrupters is nearly completed.

IV-1 gives the schedule for the facility development which awaits utility wiring to power the system. This is being connected now. The upgrading to the 20 kA, 60 kV capacity requires adding available components-capacitors, metal-to-metal switches, etc. and additional cabling. By that time an additional 12.5 kA power supply will be added to operate in parallel with the existing 10 kA homopolar generator. The system uses a capacitor bank to supply a dummy inductive store which feeds the interrupters. The interrupters in turn, after they are opened mechanically and the arc is established, are quenched by a counterpulse system which also controls the  $dI/dt$  when the current approaches zero and the  $dV/dt$  following current zero by means of a small capacitor and a saturable reactor. This allows time for deionization and the arc is shut off. The loads on the pulsed circuit will originally be resistive. All of the work is being done out of the normal operating expense budget.

IV-2 and IV-3 schedules the testing of the circuit breakers. The 10 kA, 40 kV breakers were purchased in FY-74 from Ross Engineering and Maxwell Laboratories. The former use two series connected breakers to stand off the 40 kV and are opened mechanically by means of solenoid actuators which are driven by means of a capacitor bank supplied by Ross as a part of their package. The Maxwell Laboratories switch system is a single breaker which operates in an oil bath to stand off the voltage and to dissipate the heat if a long, nonpulsed current charge is used in operation of the breaker in series with an energy storage coil. Both switches are first to be pulse tested into a resistive load, then in an LCL resonant circuit, see V-4, at a low current level and then with the full 10 kA capacitive transfer energy either with the existing pulse coils or the 300 kJ storage coil, see IV-4 and V-4.

If the tests on the 10 kA, 40 kV breakers are successful, then additional similar switch systems will be purchased with the FY-75 \$25,000 major procurement funds allocated to increase the current capacity to 20 kA and the voltage level to 60 kV. These expanded systems will then undergo similar tests as set out above for the 10 kA, 40 kV switches and should be complete by mid FY-76.

The 20 kA capacitance transfer tests would be done using the existing pulse coils already in the test facility and will have to wait for testing with a superconducting energy storage coil until late FY-77, see I-3. The work on these breakers at 20 kA and 60 kV is to be funded from the normal operating budget except for the \$25,000 major procurement to purchase expanded switch systems.

This discussion has brought into the picture the meaning of the schedules for IV-4. IV-5 merely represents a beginning of construction and testing of HVDC interrupters for the  $\lambda/2$  Coupled Superconducting Prototype System, see VI.

V. Category V outlines the schedule for operation and modification of the 375 kJ superconducting energy storage facility. This facility, originally called the 300 kJ test facility, is to be upgraded to handle the testing of the prototype  $\lambda/8$ , FTR storage coils. For instance, the new plastic test dewar will be installed in this facility, see III-4 and V-5. V-1 indicates the upgrading of the voltage and current levels to 60 kV and 20 kA in FY's 75 and 76. V-2 indicates operation of the facility at the 300 kJ level for testing the first set of industrial coils into FY-76. V-3 indicates use of the test facility for capacitance transfer or resonant circuit (LCL) energy transfer for testing of the 10 kA, 40 kV circuit breaker systems and the 20 kA, 60 kV circuit breaker systems after checking out the system. This constitutes the use schedule for the system prior to its enlargement to handle the larger energy storage coils. FY-76 and early FY-77 will see the installation of the new plastic dewar occur, the enlargement of the capacitor bank, and system checkout followed by use for prototype coil testing. No new major procurement costs are revealed here and all expenses will be met from the normal operating expense budget.

VI. Category VI represents the joining together of the many items or components developed as part of the cold METS program, all of which have been discussed above. The goal of this category is to create in the laboratory a demonstration of the successful operation of a segment of the toroidal energy transfer and storage system to prove engineering feasibility. The  $\lambda/2$  coupled superconducting prototype system will serve to

solve many physical interface problems; will function as a test bed to identify and resolve the energy transfer complications; and will integrate together the disciplines of electrical engineering, cryogenics, pulsed controls and circuitry, and engineering physics.

Some of the items in VI are specific components from other program categories of this document. For instance, the dewar (VI-8) is from III-3 and the refrigerator (VI-11) is from III-2. Thus it is apparent that the  $\lambda/2$  system is very dependent upon the timely and successful development of many other items. Interestingly enough, it is safe to say that half the items listed under this category are nonexistent now, require technology development, and any one of these can delay the entire effort if its creation is faulty or untimely. As presented, the schedule considers the long lead and pacing items - dewar, refrigerator, and 375 kJ storage coils. It provides for fabrication of a number of major components after their development as parts of the program discussed under prior categories, and assumes a completed assembled system by mid FY-78 with testing (energy storage and transfer) from then until early FY-79 of a coupled assembly of four 375 kJ coils as a system.

No refined cost figure is set out herein for the integrated system and a study is underway to develop this figure. A rough estimate of new major procurement funds for this work, exclusive of items VI-8, 11, and 13 already listed elsewhere in this document, is set at \$300,000 to \$500,000. This would be spread nearly one-third, two-thirds between FY's 76 and 77 respectively. Item VI-14 is identified as a new power supply with an installed capital equipment cost of \$40,000 - \$27,000 in FY-76 and \$13,000 in FY-77. The data acquisition system is estimated also to require capital equipment funding. This should be about \$35,000 most of which would be committed in FY-76. It should be noted that the capital equipment costs indicated as required in this document are specific to the particular program items discussed and are above and beyond the usual capital equipment budget requests submitted annually; however, they would become a part of the same budgets.

VII. Category VII deals with a half-wave test section of FTR using room temperature storage coils. This section has two primary purposes. The first is to do early testing of the implosion system, vacuum interrupters, switching, and controls. The second is to develop an alternative power source.

We propose to charge the ambient temperature storage coils in 200 ms with a 2 MJ homopolar generator. The machine would deliver 80 kA at a voltage of somewhat over 300 V. Thus the ambient temperature storage coils would be charged in parallel.

The use of a homopolar generator is predicated on the results of a Westinghouse design study which indicates that a homopolar device is an alternative to the reversible superconducting system now considered for the RTPR. In the RTPR, a 30 msec rise of the magnetic field is required; hence, the development of a fast-pulsed homopolar is viewed as part of the long range program on energy sources for the RTPR.

The design of the homopolar generator will take most of FY-75 with its construction taking another year followed by several months of testing to the end of FY-76. The ambient temperature storage coils and the compression coils would be designed in FY-75. All component and material procurement and fabrication would proceed in late FY-75 and early FY-76. The coupled, ambient temperature system would be assembled in late FY-76 with experiments to begin at the end of FY-76 after debugging of the system has occurred. The cost of the program (VII-1, 2 and 3) is estimated to run \$650,000 distributed as follows: \$200,000 FY-75, \$300,000 FY-76, and \$150,000 FY-77. Of this amount about \$175,000 in FY-76 is a capital equipment cost for the generator, and the balance for all other years is new major procurement costs.

VII designates a study being conducted under contract with Westinghouse. The study broken into two phases, is a preliminary evaluation of possible power supplies to be used to operate or feed the RTPR. Included in the Phase I evaluation is an intercomparison of various ambient temperature as well as superconducting energy storage sources. Phase I is presently funded with FY-75 major pro-

urement money. This part is nearly complete. Phase II will be a study in depth following the Phase I work and will examine the most promising energy sources. This part of the study will cost \$50,000 major procurement money and is to be completed in FY-75.

#### SUMMARY

This document describes the program and costs primarily associated with the design, construction, and operation of a  $\lambda/2$  coupled superconducting prototype system to demonstrate engineering feasibility of a METS-FTR system. It also concerns related development work to support the prototype design and component development. In addition it treats some aspects of alternative approaches to a cold METS system, see VII. The program and costs outlined here appear to diminish after FY-77, but in fact we expect a continued and increasing effort. The discrepancy is that the direction of the program after FY-77 is largely dependent on the results up to that point. For example, it is believed that a second iteration will be required on a number of items. Among these, but not programmed as bars on Fig. 2 since the exact direction of these iterations is not known, would be the possibility of having to extend the work on mass production development of superconductor. This, for instance, would be an extension of II-4 or II-6 if the first effort proved to be nonproductive or marginal in the nature of the results. A similar situation could arise, for example, if the testing of the 375 kJ prototype coils under I-3 showed the designs were inadequate. Prospectively, a more likely occurrence will be the need to design and build one more set of prototype coils as the METS-FTR reaches a final design stage. The possibility that changes in going from the present conceptual design parameters to a final design will be great enough to cause some final prototype coils to be made is not entirely remote. Similarly, this will require extension of all the work under II-4 for prototype coil superconductor.

For these reasons it is strongly suggested that the major procurement requirements will continue to increase in time beyond FY's 76 and 77. Similarly, deferred funding of the proposed level

of effort will project increased costs into subsequent fiscal years as programs are delayed.

Table II is a summary of the new major procurement costs and the unusual capital equipment costs associated with the proposed program. The table includes only a minimal amount of cost data for FY-74 as is consistent with the understanding of the text of the document. Considerable detail for FY's 75 and 76 is included. The extension of the superconducting wire and cable development work under II into FY-77 has been carried out in more detail. The  $\lambda/2$  coupled superconducting prototype system cost has been projected into FY-77 as has the  $\lambda/2$  ambient temperature METS-FTR system. A last set of numbers has been added in the table under "Other Projected Needs" to indicate an onward going level of funding for major procurement with a continuing increase beyond FY-76 and to pick up miscellaneous items in FY-75.

The total major procurement costs in Table II increase from \$1,129,000 in FY-75 to \$1,700,000 in FY-79. The peak in the totals for FY-76 arises from heavy cost needs for superconductor work, prototype coil fabrication, and  $\lambda/2$  coupled superconducting prototype system component purchases. The proposed program is seriously underfunded in FY-75 by \$586,000 in the major procurement item. A large portion of this falls into the 375 kJ prototype coil design (I-3) and the ambient temperature  $\lambda/2$  prototype system (VII-1, 2, 3). Unfunded items are noted for FY-75 by parentheses enclosing the dollar amounts.

Table III has been added to provide perspective among the items discussed in this document and the total program cost. The total major procurement costs and unusual capital equipment (special) costs are taken from Table II. The item in the table

identified as "All Other Costs" includes salaries, indirect costs, and materials and services costing less than \$2000 per item. For FY-75 only this item includes the FTR energy storage work being done in CTR-4 which costs \$116,000 - \$71,000 for salaries, indirect, and materials and services plus \$45,000 for major procurement. The balance - \$991,000 - of the "All Other Costs" item for FY-75 is for salaries, indirect, and materials and services costing less than \$2000 per item for the METS program. The FY-75 "Total Program Cost Actual" is the presently approved financial plan for the METS program as compared with the \$2,236,000 needed to perform at the rate and level proposed in this document. The rest of the table projects the extension of the total METS program cost through FY-79 to maintain the effort outlined.

It is proposed that the program and schedules outlined in this document are necessary elements of the successful pursuit of a  $\Theta$ -pinch fusion test reactor (FTR). The program has been carefully considered and established on the basis of logical stepwise development of an engineering feasibility demonstration of a segment of a toroidal energy storage and transfer system. The loss of significant progress in any one of the many interrelated items will seriously hamper the overall program. The schedules and costs contained herein are believed to be practical and to represent a reasonable rate of progress provided that funding is available and that no unforeseeable technological barriers are encountered. This document presents the proposed program of the Los Alamos Scientific Laboratory, group CTR-9, for the next several fiscal years and is intended to satisfy the request for a "Management By Objective" statement for the METS-FTR program.

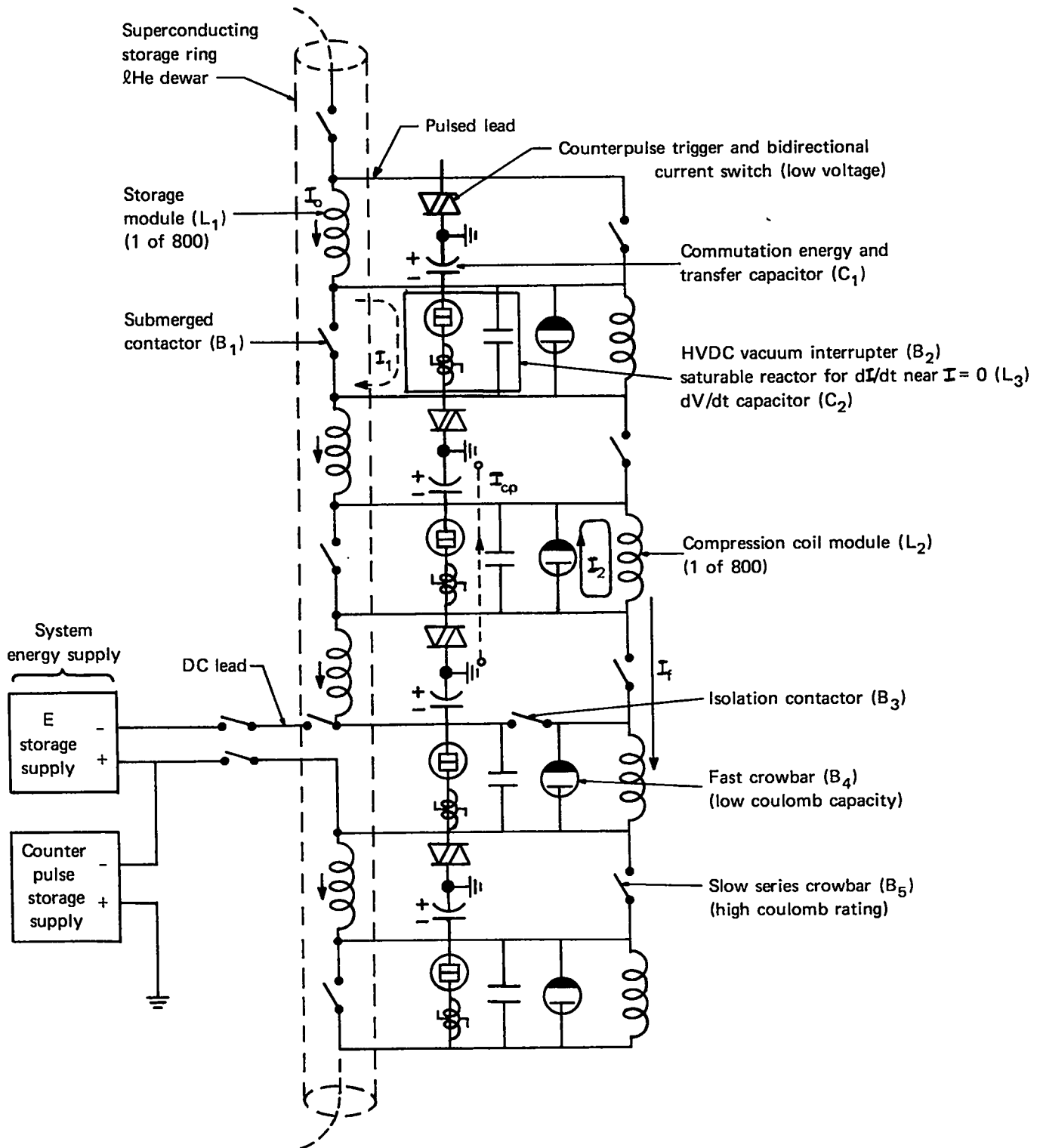

Figure 1: Superconducting METS-FTR Circuit Diagram



TABLE I  
METS-FTR CIRCUIT COMPONENTS

Energy Supply

Main	1-2 MW to ramp current to 20 kA in 300 second charging cycle. Energy stored = $800 \times 375 \text{ kJ} = 300 \text{ MJ}$ . Current leads from main supply enter circuit at a point which remains at low voltage at all times.
Counterpulse	50 kW supply. It charges up the transfer capacitors to several kV reverse by raising the full system off ground potential. 1-2 MJ needed for counterpulse, total.
Inductors	$L_1$ Storage module, superconducting. $L \simeq 2 \text{ mH} (= 15/8 \text{ mH})$ $E = 375 \text{ kJ at } 20 \text{ kA}$ $V = 58.9 \text{ kV during } 1 \text{ ms transfer, peak}$ $B = 3 \text{ T}$
	$L_2$ Compression module, multiturn copper. $L = 15/8 \text{ mH}$ $\lambda/8$ section, 27.5 cm of toroidal circumference $B = 6 \text{ T in } 30 \text{ cm i.d.}$ $L/R \leq 100 \text{ ms}$ $E = 310 \text{ kJ when } B = 6 \text{ T inside bore.}$
	$L_3$ Saturable reactor to allow preferred $dI/dt$ near $I = 0$ during commutation. Parameters to be determined.
Capacitors	$C_1$ Transfer capacitor $\left\{ \begin{array}{l} C_1 = 104 \mu\text{F} \\ V = 60 \text{ kV} \end{array} \right.$ sets transfer time and peak voltage during transfer. It is reverse charged to $\leq 5 \text{ kV}$ to supply counterpulse current.
	$C_2$ Transient capacitor to handle the overcurrent during commutation and limit voltage on HVDC interrupter during deionization period, several $10^3 \mu\text{second}$ .

Breakers, Contactors Crowbars

- $B_1$  Submerged contactor within  $\text{He}$  cryostat. It carries the charging cycle current up to 20 kA. It is to be designed for a power loss  $< 10 \text{ W}$  at full current ( $\leq 25 \text{ m}\Omega$ ).
- $B_2$  HVDC vacuum interrupter, or equivalent. This closes just prior to  $B_1$  disconnecting, current transfers into the pulsed lead ambient temperature loop to  $B_2$ .
- $B_3$  Isolation contactor. Removes E storage voltage from compression coil module during charging cycle.
- $B_4$  Fast crowbar. Crowbars compression coil module at peak current. ( $I = 20 \text{ Colombs/ms}$ ) could be in parallel with  $B_5$ .
- $B_5$  In-line closing contactor. This relieves  $B_4$  after several milliseconds, and the last  $B_5$  closing completes the loop. Voltage drop across each  $B_5$  insufficient to maintain  $B_4$  conduction, extinguishing all  $B_4$ 's.

Figure 2: LOS ALAMOS SCIENTIFIC LABORATORY MAGNETIC ENERGY TRANSFER AND STORAGE PROGRAM

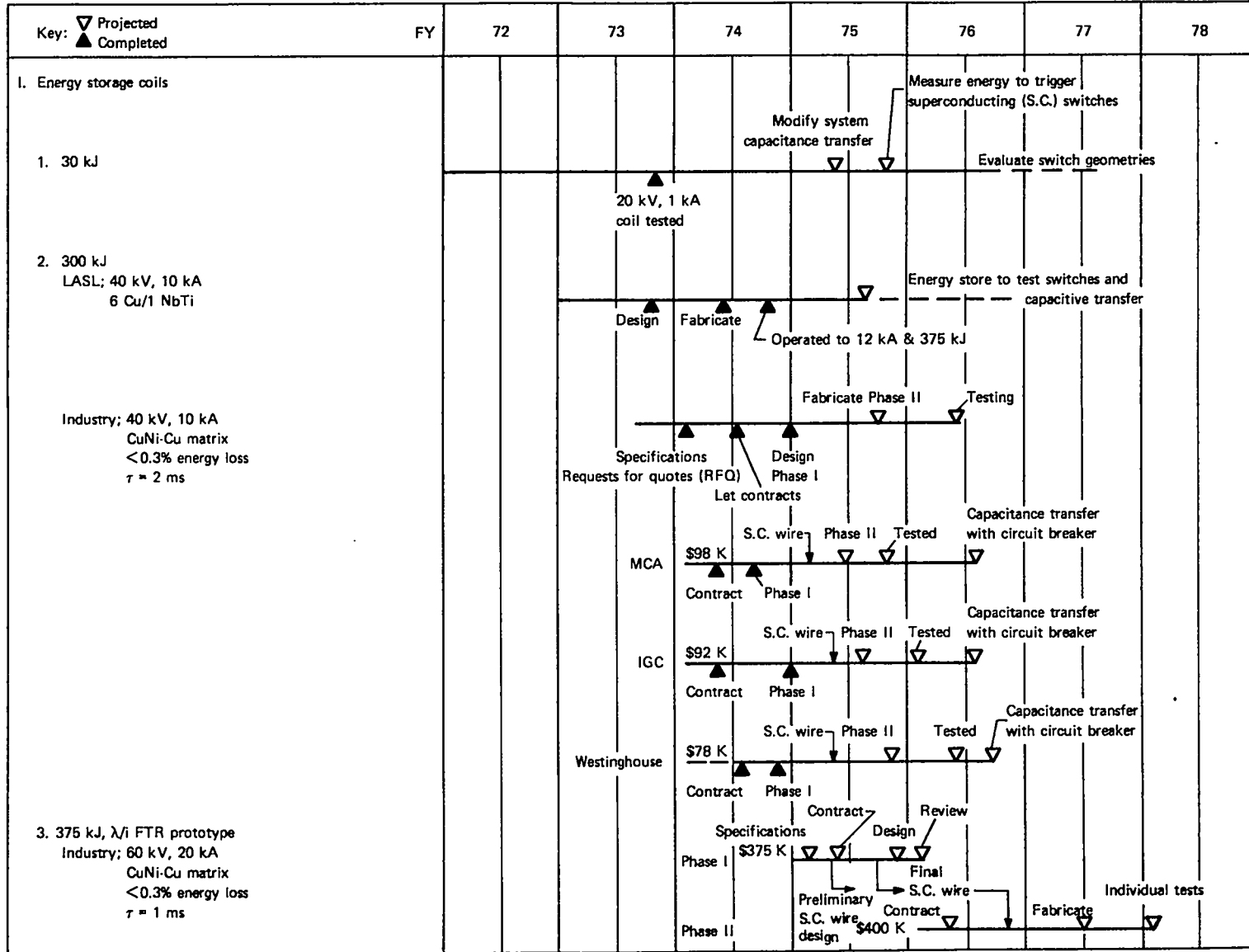

Figure 2 (continued)

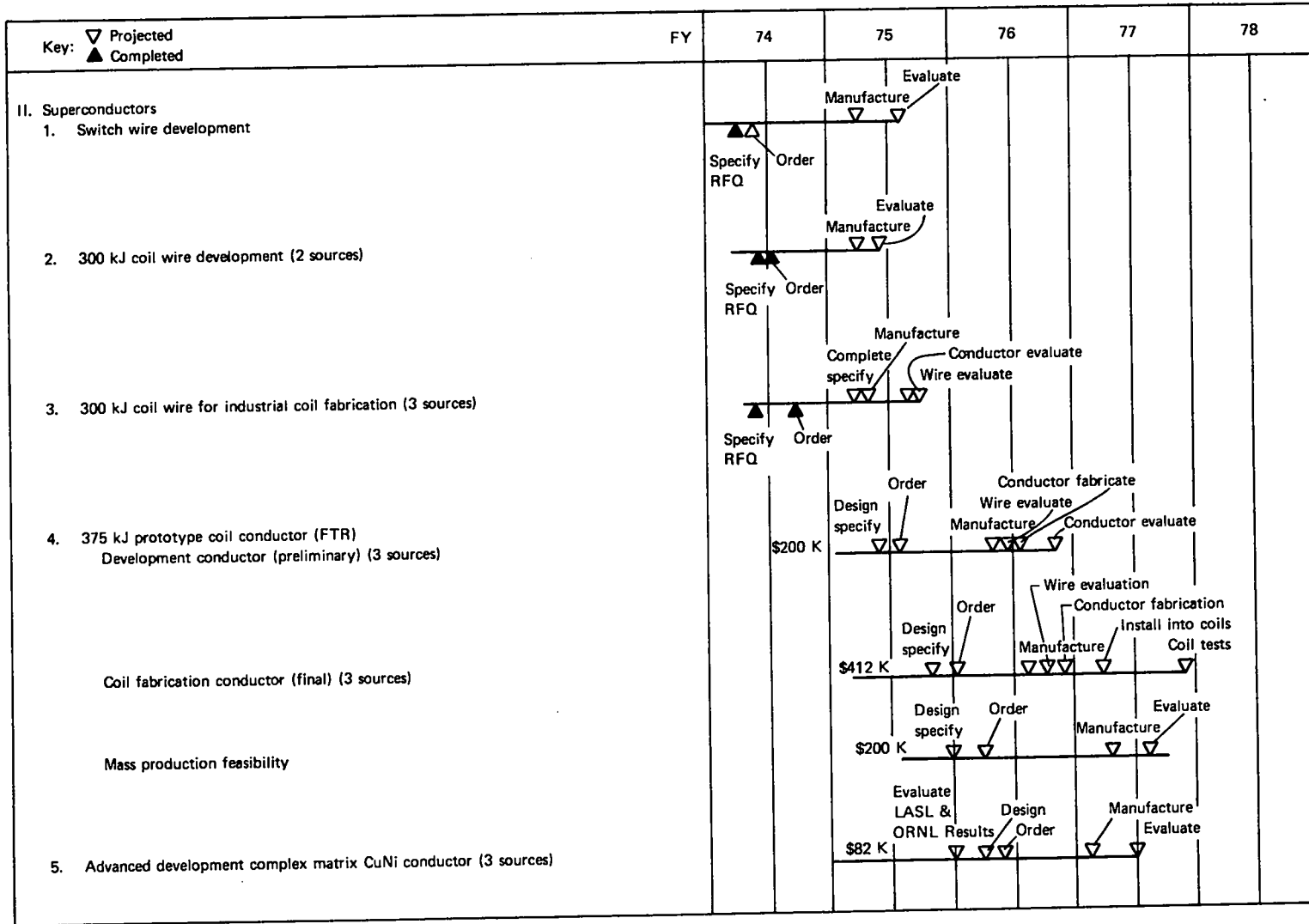

Figure 2 (continued)

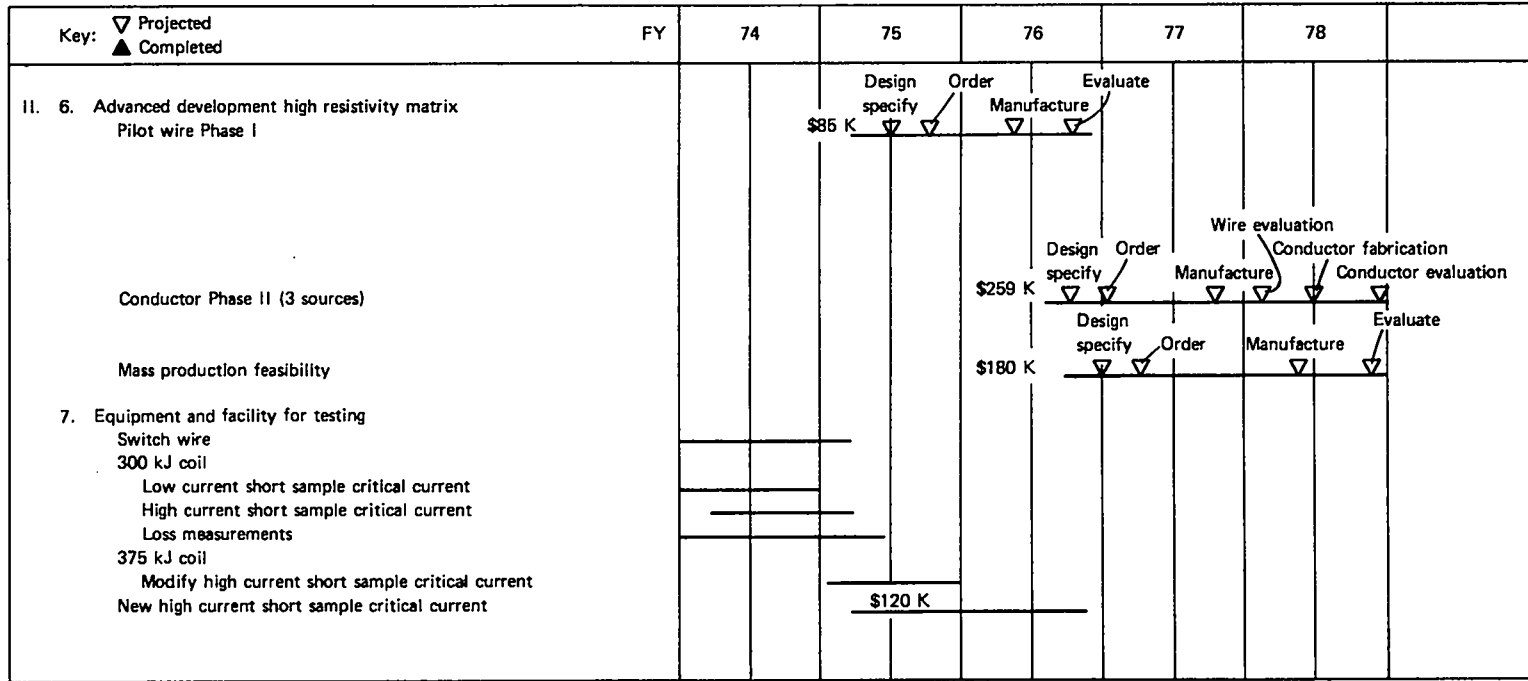

Figure 2 (continued)

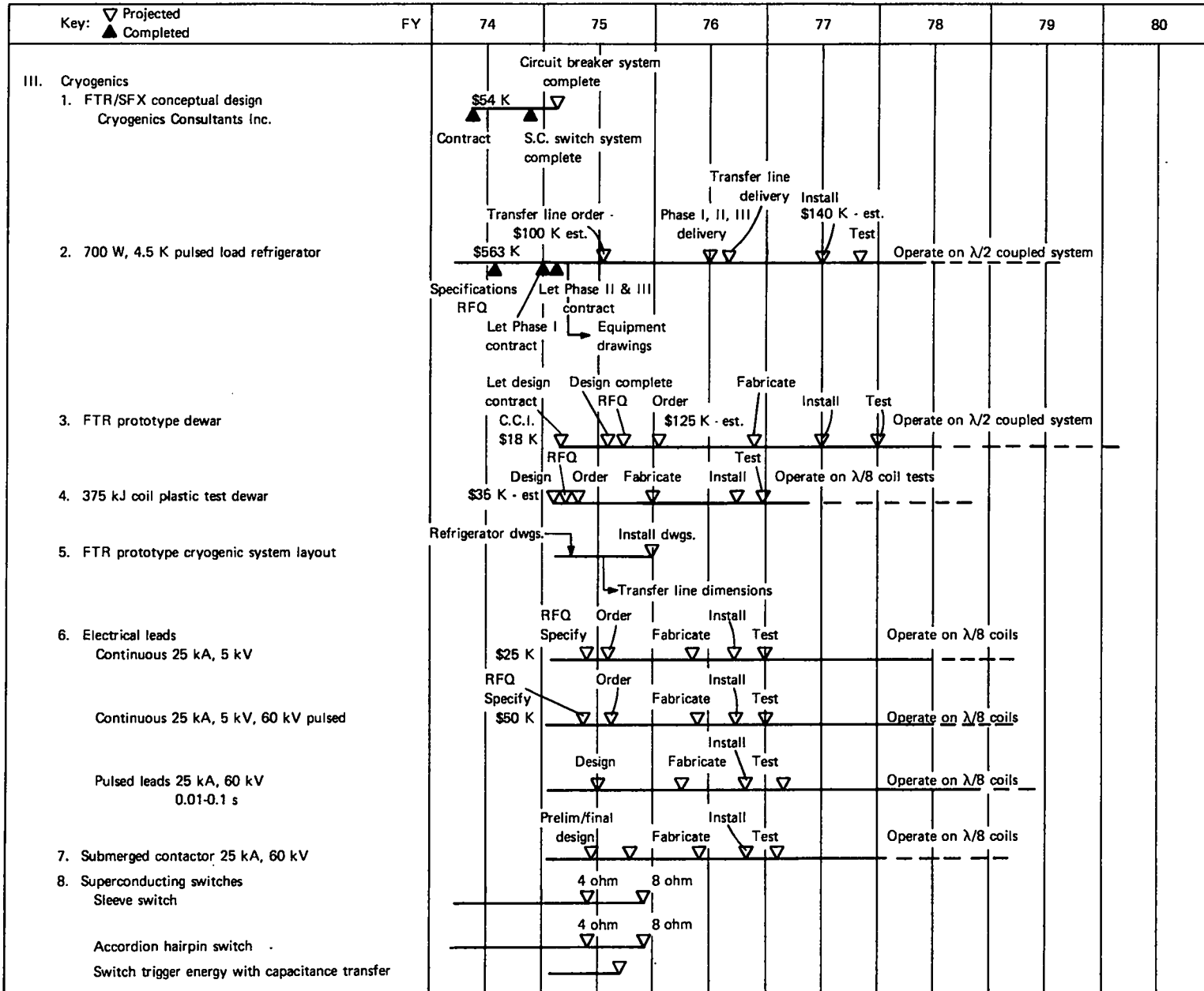

Figure 2 (continued)

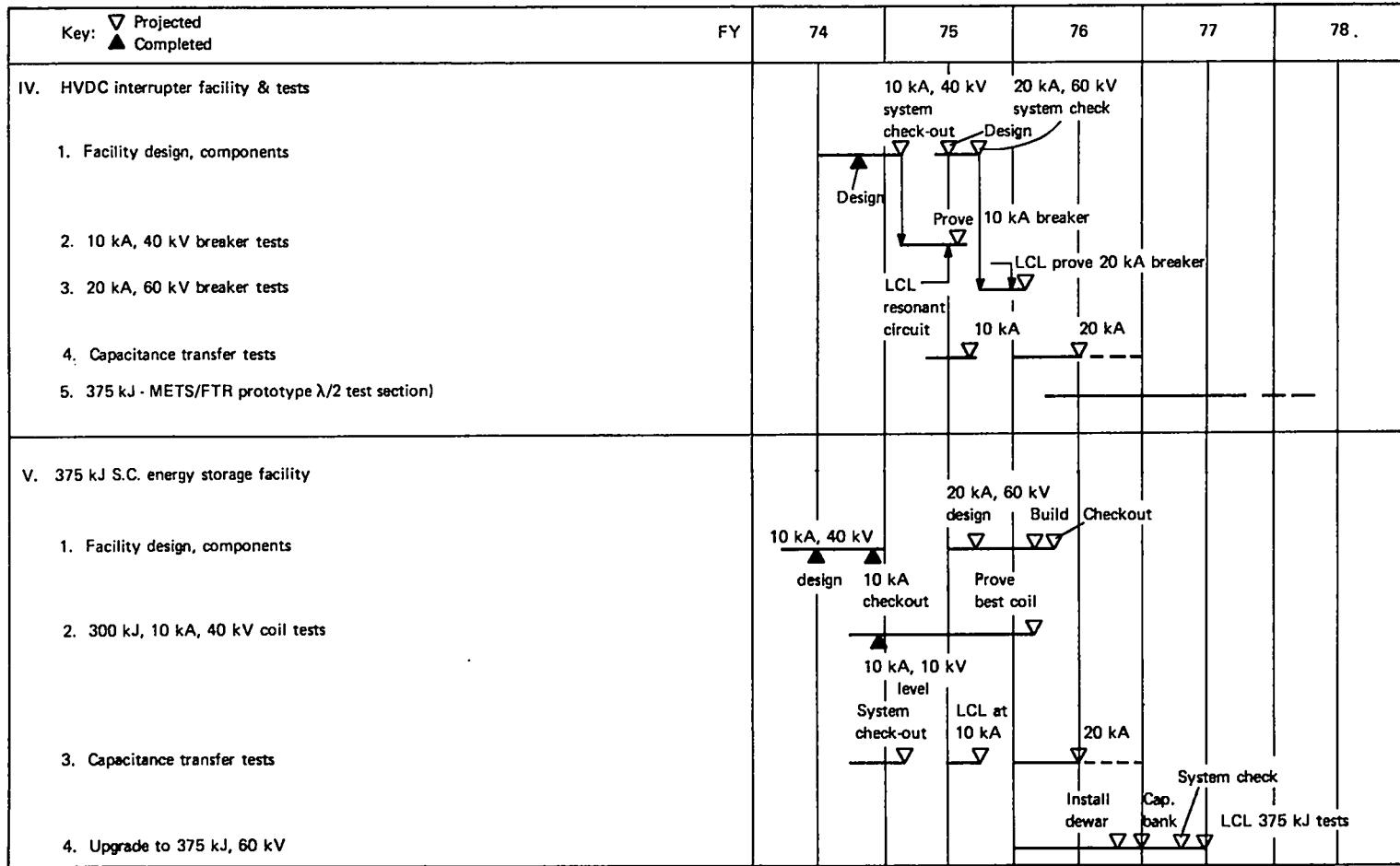

Figure 2 (continued)

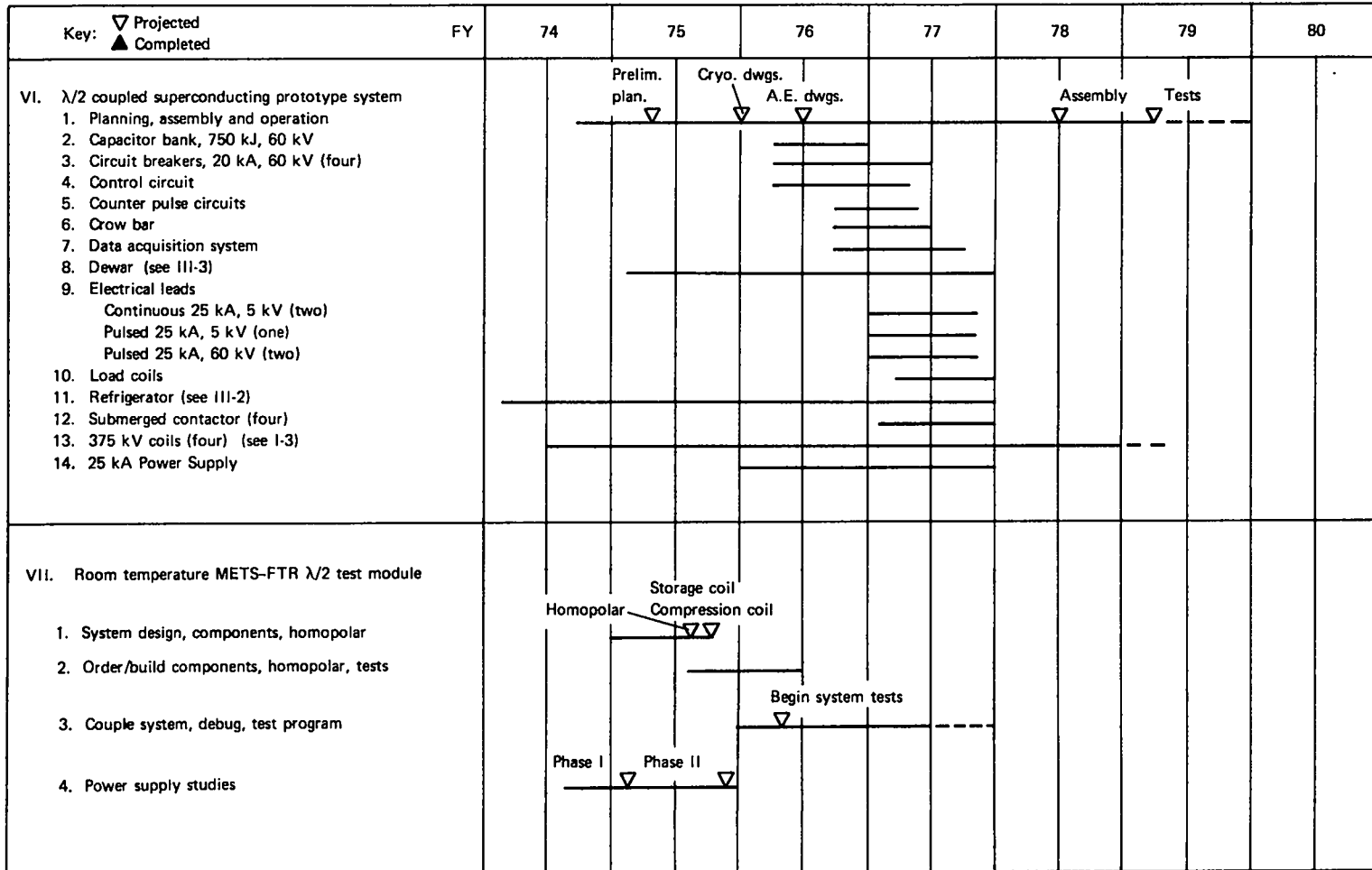

TABLE II  
MAJOR PROCUREMENT AND CAPITAL EQUIPMENT COSTS AMOUNTS IN THOUSANDS OF DOLLARS

Program	Item	Fiscal Year					
		1974	1975	1976	1977	1978	1979
I.	1	---	---	---	---	---	---
	2	160	108				
	3		124 (251)	150	250		
II.	1		nil				
	2		13				
	3		94				
	4 Development		(85)	85			
	4 Fabrication			375			
	4 Mass Production			100	50		
	5			35	20		
	6 Phase I			10	45		
	6 Phase II			100	125		
	6 Mass Production			75	75		
	7			CE 30*			
	7			25	25		
III.	1		9				
	2	CE 200	CE 363	CE 140			
	2			100			
	3		18	125	→ ?		
	4		35				
	5	---	---	---	---	---	---
	6 Continuous		25	50			
	7	---	---	---	---	---	---
	8		4				
IV.		---	---	---	---	---	---
V.		---	---	---	---	---	---
VI.				200	300		
	Data Acquisition			CE 25	CE 10		
	Power Supply			CE 27	CE 13		
VII.	1, 2, 3		(200)	125	150		
	2			CE 175			
	4 Phase I		25				
	4 Phase II		(50)				
	Other Projected Needs		88		200		
	Total Major Procurement		1129	1555	1240	1400	1700
	Unfunded Major Procurement		(586)				
	Total Capital Equipment		363	397	23		

\* CE denotes unusual capital equipment items beyond usual requirements



TABLE III  
TOTAL PROGRAM COST IN THOUSANDS OF DOLLARS

	Fiscal Year				
	<u>1975</u>	<u>1976</u>	<u>1977</u>	<u>1978</u>	<u>1979</u>
Total Major Procurement	1129	1555	1240	1400	1700
Unfunded Major Procurement	(586)				
All Other Costs	1107	1300	1550	1800	2070
Total Program Cost Requested	2236	2905	2790	3200	3770
Total Program Cost Actual	1650				
<hr style="border-top: 1px dashed black;"/>					
Capital Equipment (special)	363	397	23		
Capital Equipment (regular)	47	103	97	100	100
Total Capital Equipment	410	500	120	100	100

## APPENDIX A

### SPECIFICATION

#### 300 kJ SUPERCONDUCTING INDUCTIVE ENERGY STORAGE COIL DESIGN AND FABRICATION

##### Design and Fabrication of Superconducting Energy Storage Coils

###### INTRODUCTION

The Los Alamos Scientific Laboratory wishes to develop competence of commercial interests to design and make superconducting, inductive energy storage coils and systems. This is part of a long range program to provide pulsed energy systems for fusion reactors. The more immediate goal is to design and commence construction of a Scientific Feasibility Experiment (SFX) in FY-1977-78. The SFX, which is to be a toroidal system of about 180 meters length, will be the major predecessor to a fusion reactor. A number of scaled experiments are to be run in sequence first to demonstrate the concept of storing energy and then transferring it in millisecond times and at high voltages from the storage unit to a load coil. These experiments (Magnetic Energy Transfer and Storage, METS) are to be conducted at the 300 kJ level in a test facility nearing completion at the Los Alamos Scientific Laboratory (LASL). The subsequent experiments will evolve, to an extent, from the 300 kJ tests and will be made on storage coils or modules which will be near 1.5 MJ to 6 MJ in size. These modules are, in turn, to be production prototypes of sections of a 300 MJ SFX. The schedule for obtaining the prototype modules is to place the orders during the summer of 1974 with culmination of their testing in FY-1975-76.

The immediate plan is to obtain 300 kJ storage coils to performance specifications given below as a basis for satisfying the goals of the first series of experiments and to create an industry oriented competence for the next series of experiments.

The work will be performed in two phases:

The work phase is to be submission of the detailed, 300 kJ coil design with comprehensive technical information supporting the design for approval by LASL.

The second phase will be the fabrication and delivery of the coil with final report and drawings in accordance with the LASL approval at the end of Phase I.

###### DESIGN GOALS

Design goals are given for the 300 kJ superconducting energy coils to be purchased under this portion of the program and are outlined below. The Seller shall exert his best efforts to achieve the design goals set forth herein:

1. The 300 kJ coil is to be compatible with the existing test facility at LASL, must fit into our existing dewar, and adapt to the existing electrodes for charging and discharging. The coil must also be a thin solenoid of approximate 60 to 75-cm length and with the largest diameter to fit into the test dewar to maximize the transformer coupling of the existing test facility. LASL drawings series 55Y-88176, sheets E-3, D-4, D-5, D-6, D-10, D-15, D-16, D-20, D-22, D-23, D-25, D-29, D-30, E-31, D-32, C-33, C-34, D-35, and series 33Y-180009, sheets D-1 and D-2 are included for information purposes. The 55Y-88176 series drawings show the test dewar and a 300 kJ storage coil to provide dimensional and physical relations.

The 33Y-180009 series shows the secondary of the transformer (the storage coil is the primary) and the load coils, both located externally to the test dewar. Not all the detailed sheets of the two series of drawings are included but are available, if needed, upon request. Modifications of the present facility can be considered to accommodate new storage coil designs.

2. The coil is to carry 10 kA current under normal design conditions and should be over-designed to handle 12 kA.
3. Inductance is to be six millihenries.
4. Coil must be constructed in such a way to support 40 kV across the terminals at time of discharge in a liquid helium bath. The coil may be tested for 40 kV insulation integrity at room temperature in air and must meet the liquid helium, 40 kV requirement.
5. Energy to be stored is 300 kJ  $\pm$  5%.
6. Magnetic field level is to be in the range of 20 to 30 kG.
7. Superconducting material is to be Nb-Ti alloy and the superconductor is to be as near to the state of the art as possible and still meet the performance specifications. The design point along the field-current load line of the superconductor is to be at least two-thirds of the value of the short sample critical current value obtained by extrapolation of the load line to the short sample critical current curve. It is expected that some departures from the state of the art for superconductor will be needed to meet the performance specifications.
8. Discharge time is to be 0.002 seconds. This is the time to discharge the 300 kJ stored energy into a resistive, inductive or combined inductive-resistive load such that the magnetic field corresponding to the 300 kJ energy level has been reduced to 37 percent of its original maximum magnet field value.
9. Charging time from zero current to 10 kA is to be ten seconds.
10. The total cycle time from the time to start charging including all lapsed time through complete discharge to the time to start the

next charging phase is to be less than 30 seconds.

11. The combined eddy current, self field, and hysteresis energy losses on discharge must be less than 0.3% of the 300 kJ energy stored.
12. The coil is to be cooled by liquid helium. Forced flow of liquid helium over the superconductor must be considered. Supporting heat transfer and heat conduction calculations for the 300 kJ and a conceptual 1.5 MJ prototype must be made. If these calculations indicate the need for forced cooling of the 1.5 MJ prototype coils operating with 0.3% energy losses per cycle for a ten minute cycle with a 0.001 second discharge period then the 300 kJ coil must incorporate a forced-flow cooling capability. Forced flow cooling through a hollow conductor is discouraged from consideration. The 300 kJ coils for the present program are to be operated with their axis vertical, whereas larger coils will undoubtedly have their axis horizontal. Although this not an overriding consideration for the 300 kJ designs, appropriate coolant passages for the horizontal configuration might be made a part of the 300 kJ coil design. The possibility exists that a lack of any reasonable engineering relation might exist between forced flow cooling of a 300 kJ coil and a 1.5 MJ coil even though the calculations for a 1.5 MJ prototype coil indicate forced flow will be required for the larger coils. In this event and only if such nonrelation is clearly established, a pool boiling, free convection design for the 300 kJ coil will be considered. If cooling of a 1.5 MJ prototype coil can be accomplished by free convection pool boiling, then the 300 kJ energy storage coil should be designed accordingly. In any circumstance the 300 kJ coil must have appropriate coolant channels incorporated in the design. The heat transfer design must also provide for cooling of the coil in ten minutes from an accidental transition from the superconducting to normal conducting state when in the full 300 kJ energy storage state at the time of the transition.

The following parameters define the prototype superconducting energy storage coil:

Inductance 0.0021 henries  
Number of turns 46  
Radius 35 cm  
Length 50 cm  
Current 25 kA  
Voltage 40 kV  
Field 30 kG (average)  
Energy stored 0.63 MJ

13. The coils are to be tested in a nominal 4.2 K to 5 K liquid helium system.
14. The coil structural material must be nonconducting.
15. Cycling the coil from room temperature to liquid helium temperature and back to room temperature is not to cause degradation of coil performance. Reasonable programmed thermal cycling provisions to avoid degradation are acceptable provided the design is consistent with the cycling proposed.
16. The coil must be able to undergo complete energy charge and pulsed discharge cycles without degradation or going normal.
17. Accidental transition from the superconducting to normal conducting state should not degrade the storage coil.
18. The coil is to be charged from a homopolar generator when tested at LASL. Current-voltage characteristics of the generator into a resistive load can be supplied.
19. LASL will furnish the wire for the coil in accordance with the Seller's design.

#### DISCUSSION

The 300 kJ superconducting, energy storage coils to be purchased by LASL are to be tested by LASL to determine whether they meet the performance specifications. Materials and workmanship are expected to be the highest quality.

The test facility at LASL consists of a super-insulated, nominal 24-inch inside diameter fiberglass-epoxy, liquid helium dewar. It is equipped with a demountable lid for suspending the coils. The lid is penetrated with instrumentation ports, a major venting port, and two vapor cooled 8 kA leads, which are capable of operating at 12 kA for

short periods of time. These electrodes or leads are insulated for 40 kV operation. The 300 kJ coil must be designed so that it can be mounted on a G 11 center post from the lid and have its superconductor attach to the electrodes with joint resistance of about  $10^{-9}$  ohms. The connection to the leads must, for present purposes, allow for relative thermal expansion between the leads and the storage coil. Because of the forces between the storage coil (primary) and the transformer secondary as a result of magnetic field misalignment at the time of the pulsed energy transfer, certain considerations must be given, as in the present 300 kJ coil design, to the physical stabilization of the coil.

The process of testing the coils will involve connecting the coil in series with a homopolar generator and a superconducting switch. The circuit of interest is Figure 2(b) of LA-5314-MS. The coil is to be charged to 10 kA in 10 seconds and then discharged in 2 milliseconds by driving the switch normal in a few microseconds time by a capacitance discharge. The superconducting switch and external protective resistor can be varied to obtain different magnitudes of resistance in series with the coil, thus determining the discharge time and the back emf developed across the coil. The switch is located in its separate dewar.

The energy is coupled into a transformer winding and a load coil. Since the transformer coupling is poor and use of the superconducting switch consumes large amounts of helium, an alternative test procedure is to be used to direct couple into an external resistor or into an external resistor - inductance circuit. Observations of the decay times for the latter circuit should supply information on whether the superconductor has gone normal.

The report, LA-5314-MS, gives considerable information on the experimental effort behind the METS program.

In addition to the drawings of the present system, there is included a self-explanatory, conceptual drawing of a more appropriate 300 kJ coil. Such a coil, to be made with high dB/dt superconductor, which is cabled and braided, must have low energy losses and coolant channels to remove the small amount of heat generated. First calculations

indicate that an elaborate twisted multifilament Nb-Ti superconductor which is imbedded in a copper, copper-nickel matrix should have a sufficiently high dB/dt behavior to decouple the filaments. Calculations also indicate that eddy current and hysteresis losses will be very small if the proper decoupling can be obtained.

Other calculations based upon the required low energy loss, transient heat conduction in the conductor, and heat transfer to the liquid helium bath show that the expected temperature rise in the conductor will be small and should not cause such a conductor to go normal. Calculated thermal recovery times are of the order of a few hundred milliseconds, even with film boiling heat transfer coefficients and thermal conductivities in the conductor as low as might be expected from epoxy impregnated conductor. The same calculations indicate that the pool boiling will most likely be nucleate in nature. The amount of helium gas evolved each cycle is a very small fraction of that expected to be in the coolant channels.

The problem of preventing conductor motion in the coil is of utmost importance and is of special significance to prevent degradation during thermal and electrical cycling. Because of the high dB/dt requirements of the coil it would seem that cabled or braided conductor is a necessary choice. This consideration may well lead to epoxy potted coils.

Supporting technical calculations and information for the design phase of the program must include, among other things, the basic electrical configuration; heating effects; temperature rise and cooldown; energy losses; dB/dt and superconducting filament decoupling; detailed superconductor design; both transient and steady state thermal stresses; field-force stresses; electrical insulation; materials properties - electrical, structural, and thermal; and sufficient detailed drawings to reduce the application of the design calculations to a working state and to assure compatibility with the LASL facility.

---

## APPENDIX B

### SPECIFICATION

#### DESIGN OF 375 kJ, $\lambda/8$ FUSION TEST REACTOR PROTOTYPE PULSED SUPERCONDUCTING ENERGY STORAGE COIL

The Los Alamos Scientific Laboratory wishes to continue its commercial qualification program for design and fabrication of superconducting, inductive energy storage coils and systems. The next step in the program already under way is to design and fabricate 375 prototype coils for a toroidal energy storage system. This to be done in two phases. The first is to have the participating industrial corporations make designs of coils with the end product to be originals of complete detailed shop drawings with specifications and manuals for construction and assembly of prototype coils to be used by any other manufacturer to make coils. Specifications and manuals are to include quality assurance considerations. The first phase is to be contracted separately. The second phase, to be contracted separately and not as a part of this

proposal, is to have industrial corporations build from one to four, 375 kJ prototype coils. These are to be operated individually and in a prototype, horizontally mounted assembly of four coils supplying pulsed energy with switching through a capacitive transfer system to compression load coils.

The coil design is to be a detailed prototype for installation in an 800 coil toroidal energy storage system and must consider all ramifications of the coil as related to the system. To be included in the consideration of the design among other things are:

- a. The method of assembly of the coils in the toroidal ring preferably by premounting a number of coils on a section of nonconducting dewar lid.
- b. Joining between coils and between sections of premounted coils to withstand all forces

of adjacent coils in the toroidal ring as they are assembled individually onto the sections and as the sections are assembled into the storage coil dewar.

c. Making the assembly of the last section into the dewar and allowance for shimming or adjustments to account for accumulated dimensional variations.

d. Contraction of the storage coil ring relative to the storage coil dewar.

e. Support of the coils in the dewar or from the lid.

f. Any elastic or structural instabilities which may cause the toroidal ring to kink or fold on itself.

g. Effect on one or more coils in the toroidal ring going normal or possibly losing its field. The detailed specifications for the coils

are as follows:

1. Each individual coil when operated in a 238.88 meter long circumferential toroid is to store 375 kJ energy.
2. There are to be 800 coils in the toroid.
3. Coil length on axis 0.2986 meters including structure for connecting adjacent coils, flanges, insulation, and shims.
4. Maximum coil diameter (width or distance across coil in the major radial direction of the toroidal configuration) 0.81 meters to include structure for a multi-layer coil. The height of the coil along a direction parallel to the major toroidal axis might be greater to satisfy items 21, 22, and 23 below but cannot exceed 0.86 meters. A single layer coil should have a corresponding maximum width of about 0.75 meters and a height of 0.81 meters including structure, mounting flanges, etc.
5. Current rating 20 kA as determined by a point two-thirds of the short sample critical current measured along the load line.
6. The magnetic field is not to exceed 40 kG.
7. Fringing field outside the full toroidal configuration to be less than 30 gauss at three meters from the coil axis without the use of shielding. For a four coil test section it will, of course, be much larger.
8. Support 60 kV across coil under transient pulse conditions in liquid helium. The coil

may be tested for 70 kV insulation integrity at room temperature in air and must meet the 60 kV liquid helium requirement.

9. Transfer time from fully charged carrying 20 kA to fully discharged (zero current) to follow approximately the equation

$$I = (I_0/2) [1 + \cos (2 \pi t/0.002)]$$

for a 0.001 second transfer time.

10. Also be capable of discharge into a three ohm resistive load such that the magnetic field corresponding to the 375 kJ level has been reduced to 37 percent of its original maximum magnetic field value in about 0.0005 seconds for an isolated coil. Item 9 shall be given consideration over this item.

11. The preferred design for successive coils in line around the toroid is to have the coils wound in alternate clockwise and counter-clockwise sense for single layer coils and arranged on axis with the high voltage ends together and the low voltage ends together; however, with this arrangement there is the need to provide at least 10 kV insulation between face-to-face coil ends. If a multi-layer coil design (not preferred) is proposed and if the high voltage coil ends and the low voltage ends are not paired as per above in the toroidal configuration, then more insulation between the coil ends is required.

12. Superconducting material is to be Nb-Ti alloy.

13. Energy loss during charge and discharge from all combined sources is to be less than 0.3 percent of the 375 kJ energy stored.

14. Charging time from zero current to 20 kA is to be 10 seconds.

15. The coil is to be submerged cooled in a bath of liquid helium with either individual coil operation with vertical or horizontal axis mounting or combined with a number of coils from several to 800 with their axes mounted horizontally. The coils will be operated in a nominal 4.0 K to 4.5 K liquid helium system.

16. The coil structural material must be nonconducting.

17. Cycling the individual coils or an

assembly of coils in the 800 unit toroidal system from room temperature to liquid helium temperature and back to room temperature is not to cause degradation of performance. Reasonable programmed thermal cycling provisions to avoid degradation are acceptable providing the design is consistent with the operational functions proposed.

18. The coils must be able to undergo 10,000 complete energy charge and pulsed discharge cycles without degradation or going normal.

19. Accidental transition from the superconducting to normal conducting state should not degrade the storage coils. The design is to incorporate all the necessary provisions for detecting transitions from the superconducting to normal state if these are needed to protect the coils when operated either individually or in the toroidal configuration.

20. The structural design must be such that the coils can operate individually in the vertical or horizontal axis orientation, in a vertical or horizontal stacked solenoid of up to four coils, and in a toroidal configuration of 800 coils.

21. The coils must be capable of being mounted by hanging from the top of the coil at two points of attachment, at each coil end face or flange with the coil axis horizontal, must also be provided with a mounting capability on the bottom to attach to a flat surface at each coil end face or flange with the coil axis horizontal, and be able to be hung on rods or be mounted on a center post with the axis vertical for operation of single coils. This last mounting capability can be accomplished with attachments between the coil end face flanges and the center post.

22. The ends of the superconducting cable are to come to the outside surface of the coil at opposite ends of the coil and in a plane perpendicular to the coil axis with an angular offset of about 45° from the upward vertical. See next item.

23. The end of the superconducting cable is to be interfaced with the buyer's submerged contactor design. The design must include adequate arrangements for holding the con-

ductor rigidly between the coil and the submerged contactor.

24. The design is to include a nonconducting, detachable gas shroud for collecting and measuring boiloff gas when each coil is operated by itself with its axis in either the vertical or horizontal position.

Supporting technical calculations and information for the design phase of the program must include, among other things, the basic electrical configuration; heating effects; temperature rise and cooldown; energy losses; dB/dt and superconducting filament decoupling; detailed superconductor electrical insulation; materials properties - electrical, structural, and thermal; and sufficient detailed drawings to assure compatibility with the buyer's facilities.

In addition to the information already required - original drawings and five copies, specifications (five copies), manuals (five copies) - the supplier is to supply five copies of a report containing supporting design calculations and information in keeping with the preceding paragraph.

Supplier is to provide detailed superconductor design information by 10/15/74 for the coils to be used as the basis of a superconducting cable development program with final specifications to be a part of the final results of the work under this program.

The supplier is to provide by 12/15/74 a best estimate of the cost of making a single coil, a pair of coils with opposite winding and four coils - two each with opposite winding - and the time required to fabricate the coils. These costs are to include all costs for superconductor, attaching devices, mounting fixtures, suspensions, etc. to provide for single, paired, and composite (4) coil assemblies and testing. The estimates are to include costs and time to acquire the superconductor as part of the coil fabrication by the supplier but are to be broken out as separately identified items.

All this same information is also to be supplied as a part of the completion of this work in a refined form suitable for use as the basis for negotiating a contract to have coils made to the design resulting from this study.